



**— GARDEZ VOS DISTANCES —**

**DISTANCE DE SÉCURITÉ À RESPECTER**

**DISTANCE À RESPECTER**

**ATTENDEZ - ICI**

# ADHESIFS SOL

diamètre 300 mm

9 € ht pièce  
(minimum 5 ex)



ADSOL01



ADSOL02



ADSOL03

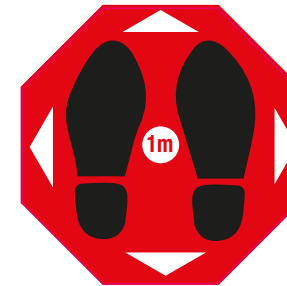

ADSOL04



ADSOL05



ADSOL06



ADSOL07



ADSOL08



ADSOL09



ADSOL10



ADSOL11

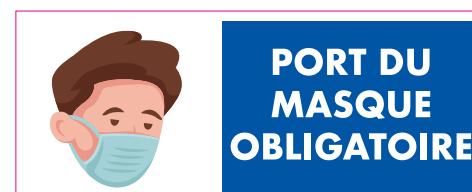

ADSOL12

500x200 mm

13 € ht pièce  
(minimum 5 ex)

Tous nos modèles sont personnalisables sur demande

# ADHESIFS SOL

ADSOL13

**MERCI DE GARDER VOS DISTANCES**

ADSOL14

**MERCI DE RESPECTER UNE DISTANCE DE 1M ENTRE CHAQUE PERSONNE**

ADSOL15

**— GARDEZ VOS DISTANCES —**

ADSOL16

**DISTANCE DE SÉCURITÉ À RESPECTER**

ADSOL17

**⊘ DISTANCE À RESPECTER ⊘**

ADSOL18

**STOP ATTENDEZ - ICI STOP**

ADSOL19

**⏚ MERCI D'ATTENDRE ICI ⏚**

ADSOL20

**ATTENDEZ-ICI — ATTENDEZ-ICI — ATTENDEZ-ICI**

ADSOL21

**ZONE D'ATTENTE — ZONE D'ATTENTE**

1000x70 mm

**8 € ht pièce**  
(minimum 5 ex)



FL01



FL02



FL03



FL04

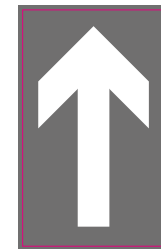

FL05

150x250 mm

**7 € ht pièce**  
(minimum 5 ex)

Tous nos modèles sont personnalisables sur demande

# ADHESIFS DIVERS



ADD01



ADD02



ADD03

100x100 mm

6 € ht pièce  
(minimum 5 ex)



ADD04



ADD05

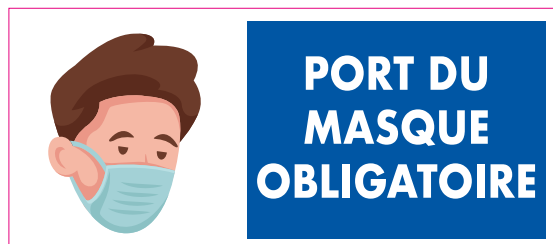

ADD06



ADD07

180x72 mm

7 € ht pièce  
(minimum 5 ex)

**PROTECTION  
COVID - 19**

COLIS EMBALLÉ  
DANS LE RESPECT  
DES NORMES  
SANITAIRES

ADD08

100x100 mm

6 € ht pièce  
(minimum 5 ex)

Tous nos modèles sont personnalisables sur demande

# PANNEAUX DIVERS

Panneaux PVC 3 mm



PAN01



PAN02



PAN03



PAN04



PAN05



PAN06

500x200 mm

**13 € ht pièce**  
(minimum 5 ex)

Tous nos modèles sont personnalisables sur demande

# ROLL UP - X BANER

STAND ROLL UP



ROLL01

850x2050 mm

85 € ht pièce

X BANNER



XBAN01

800x1900 mm

40 € ht pièce

Tous nos modèles sont personnalisables sur demande

# DISTRIBUTEUR DE GEL HYDROALCOOLIQUE

Station Gel Hydro  
fixé en mural ou sur comptoir



**ST01**

**Hauteur 442 mm  
Largeur 262 mm  
Profondeur 232 mm**

- Etagère pour Flacon distributeur.
- Cadre d'affiche A4 actualisable.

**150 € ht pièce**

Station Gel Hydro Standard



**ST02**

**Hauteur 1400 mm  
Base 500mm**

- Etagère pour Flacon distributeur.
- Support pour Boîte distributrice de gants jetables.
- Cadre d'affiche A4 actualisable.

**295 € ht pièce**

Station Gel Hydro premium

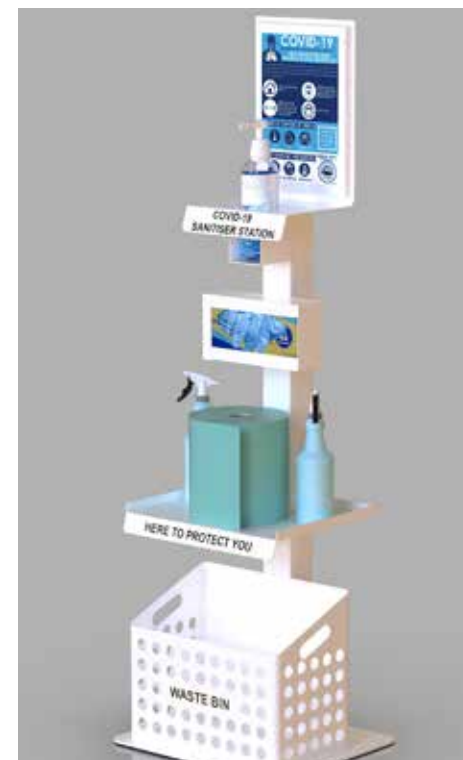

**ST03**

**Hauteur 1400 mm  
Largeur 460 mm  
Profondeur 390 mm**

- Etagère pour Flacon distributeur.
- Support pour Boîte distributrice de gants jetables.
- Etagère.
- Poubelle.
- Cadre d'affiche A4 actualisable.

**450 € ht pièce**

# DISTRIBUTEUR DE GEL HYDROALCOOLIQUE

Totem Gel Hydro

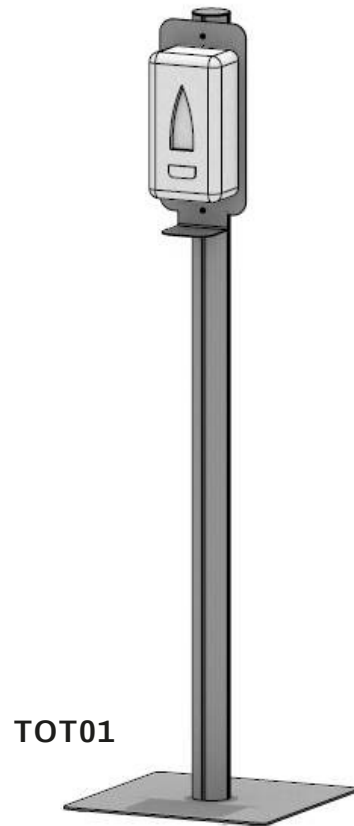

TOT01

Hauteur 1600 mm

198 € ht pièce

Totem Gel Hydro  
avec cadre A4 personnalisé

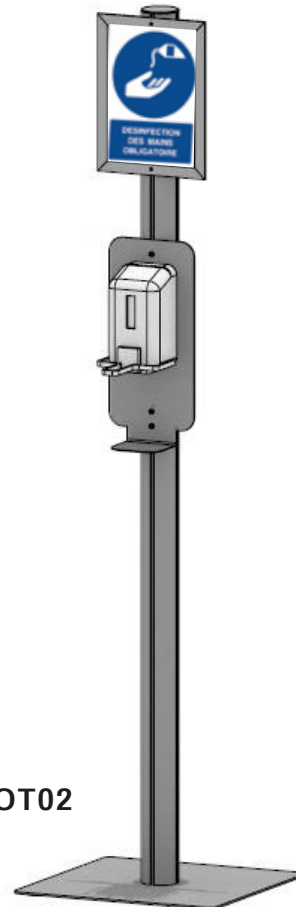

TOT02

Hauteur 1800 mm

220 € ht pièce

Totem Gel Hydro avec étagère  
et panneau personnalisé

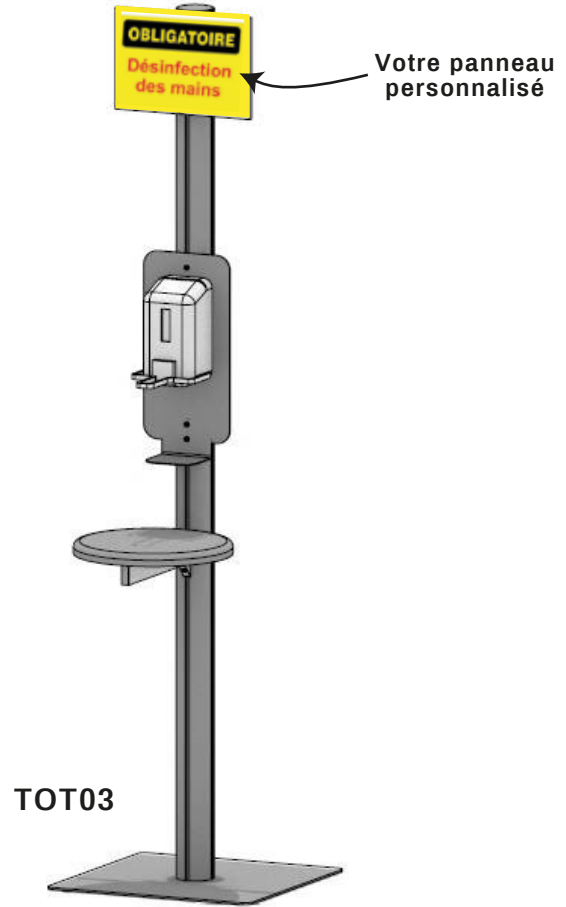

TOT03

Hauteur 1800 mm

279 € ht pièce





36, rue Félix Faure - 26100 - Romans sur Isère  
Tél. 04 75 70 72 48 - [activgraphic@mac.com](mailto:activgraphic@mac.com)  
**[www.activ-graphic.com](http://www.activ-graphic.com)**